

Article number: 03442025

Description: Fluro Rod end GE 25EC-NIRO

Measures

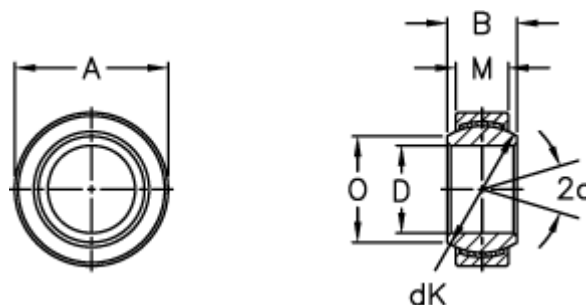

A	= 42 0 -0,011	Tilt angle = 7
B	= 20	Weight = 110
D	= 25 0 -0,010	
dK	= 35.5	
Dynamic load C (kN)	= 96	
M	= 16	
O	= 29.3	
Static load C0 (kN)	= 159	